

# RF GENERATION AND CONTROL FOR THE TESLA TEST FACILITY

Alexander Gamp

DESY

HAMBURG, GERMANY

Introduction

Klystron-Modulator Schemes

Interlocks

The RF Distribution

Phase and Amplitude Control

Beam Loading

Lorentz Force detuning of the cavities

Possible new RF sources for TESLA

## Introduction

The RF needs for the TESLA TEST FACILITY (TTF) are threefold.

The main item is made up by the four cryomodules. In each cryomodule there are eight cavities. The peak RF power needed for one nine cell cavity at full gradient and maximum beam current, i.e. 25 MV/m and 8.22 mA during the pulse, is 208 kW.

The beam pulse consists of 800 micropulses with a spacing of 1  $\mu$ s and 470  $\mu$ s are needed to fill the cavity with RF, hence the minimum RF pulse length has to be 1.27 ms. The repetition rate is 10 Hz.

For more flexibility, we have specified a minimum RF pulse length of 2 ms. This will also allow us to double the beam pulse length in order to reduce the loss of electrical energy due to cavity filling.

So, the total peak and average RF powers needed for the four cryomodules are 6.65 MW and 140 kW respectively.

The injector, which consists of a gun, a subharmonic prebuncher and a preacceleration cavity identical to the nine cell cavities installed in the cryomodules, also needs about 208 kW of RF power.

Finally, 1-2 MW of RF power are needed for high power processing (HPP) of the cavities.

For all these cases fully reflected power during some fraction of the RF pulse must be expected and circulators will be used to limit the reflected power seen by the klystrons to 1.2:1 VSWR or better.

Cavities upon fabrication are tuned to  $1.3 \text{ GHz} \pm .5 \text{ MHz}$ , however, in order to have a sufficiently fast response of amplitude and phase regulation loops, a Klystron bandwidth of 3 MHz (or more) should be more than adequate.

In addition, a power reserve of at least 5 % for amplitude regulation is required. A maximum pulse power close to 10 MW is therefore needed.

In the spectrum of the commercially available L-band Klystrons there are several tubes, which can deliver about 5 MW peak power at a pulse length of 2 ms. For 10 MW peak power the pulse lengths lie rather in the 100  $\mu\text{s}$  range. We have decided to power the four TTF kryomodules by two 5 MW Klystrons TH 2104 C from Thomson. These are conventionally pulsed cathode Klystrons without modulating anode.

One of these Klystrons will also alternatively deliver the power for HPP of the cavities. For more flexibility, the RF for the injector cavity will be supplied by an extra 300 kW pulsed Klystron. We had the opportunity to purchase several of these tubes and also high power circulators as second hand devices, which were formerly used in Plasma Physics.

In the following we will discuss possible Klystron-modulator schemes, the wave guide RF distribution system, phase and amplitude control, beam loading, and a scheme to cope with the detuning of the cavities due to Lorentz-forces. In the last section we will sketch some perspectives for the development of new RF sources for TESLA.

### Klystron-Modulator Schemes

The commercially available Klystrons, which correspond to our needs, can be divided in two categories. These are diode Klystrons without a modulating anode and devices with a modulating anode. They are schematically shown in Fig. 1.

Pulsed diode Klystrons need a pulsed cathode voltage of the order of 130 kV with a current of about 100 A in our case whereas a Klystron equipped with a modulating anode usually is subjected to a CW cathode voltage, and the electron beam current in the tube is controlled by the potential of the modulating anode. Such a modulator is indicated in Fig. 2. The advantage of this latter scheme is that the current that has to be handled by the switching tube is only of the order of an Ampere, and no pulse transformer (see below) is needed. So there is flexibility with respect to pulse length.

At cathode voltages well below 100 kV this scheme works very well.

For cathode voltages well above 100 kV, however, some tube manufacturers hesitate to recommend modulating anode Klystrons because the additional ceramic insulator necessitated by the modulating anode is a critical element and likely to cause sparking.

Note that the Klystron beam current is suppressed for modulating anode potentials close to the cathode potential, hence the ceramic cylinder between modulating anode and ground potential anode sees the full cathode voltage during the long intervals between RF pulses (98 ms in our case). The distances cannot be arbitrarily increased because of electron optics. The other ceramic cylinder sees only high voltage during the duration of the RF pulse. For pulses as long as 2 ms this is also problematic but feasible and today's state of the art.

Nevertheless, there are manufacturers who claim being able to solve or having solved these problems. We are, however, not aware of an existing modulating anode Klystron

that can deliver 5 MW pulses of 2 ms length. On the other hand, many examples of newly built diode Klystrons suitable for the TTF exist.

The procurement of a suitable hard tube for the modulator would be difficult and expensive since this tube has to endure the full cathode voltage, as is apparent from Fig. 2. Above 120 kV there is only a very limited choice of these tubes.

Other disadvantages of the modulating anode Klystron are that the capacitor bank has to be charged up to the full cathode voltage rather than to some 10 kV, as is the case for the alternatives discussed below. This implies considerable increase of crow bar cost.

Furthermore, the electromagnetic focusing solenoid of the Klystron has to be bigger and will consume more power. Finally, these tubes are more expensive than diode tubes.

These arguments and others concerning gain and efficiency led to our decision for the Thomson TH 2104 C diode Klystron. The main parameters of this tube, which were measured during commissioning in July 1993, are given in table 1.

Now we are confronted with the task of designing a cathode modulator, which produces 130 kV pulses with a current of almost 100 A.

The solution of a switch tube in series with the Klystron as depicted in Fig. 3 does not seem attractive. To our knowledge, at most one tube exists, which could switch currents of about 100 A for intervals like 2 ms. We fear that this solution, if feasible at all, would be very expensive and unreliable.

More exotic solutions like Superconducting Magnetic Energy storage (SMES), as shown in Fig. 4, merit consideration, but are certainly too far from maturity to be used for the TTF.

A proven solution consists of a Pulse Forming Network (PFN) in conjunction with a pulse transformer. It is shown in Fig. 5. This technique has been successfully used at SLAC, FNAL and at other places, but only with pulse lengths up to some hundred  $\mu$ s.

Evaluation of the costs of a 2 ms PFN stimulated search for other solutions. The very elegant solution, which has finally been adopted and which is presently being realized at FNAL<sup>1</sup> has been proposed by Quentin Kerns from FNAL and is sketched in Fig. 6.

In operation, the DC power supply keeps capacitor C1 charged to 10 kV. The output pulse is started by turning ON the GTO switch S1, which connects C1 to the pulse transformer primary. The pulse is terminated after 2.3 ms by turning the GTO OFF. The primary pulse level is 9.6 kV / 1.14 kA, and is stepped up to the Klystron operating level by the 13 : 1 pulse transformer. The need for a 2 ms pulse transformer, which is a fairly unique device, might be considered a disadvantage of this solution. We had, however, built a prototype of a 2 ms pulse transformer by industry, and commissioning has taken place at FNAL in August 1993.

During the pulse, capacitor C1 discharges by 20% of its initial voltage, putting an intolerable 20 % slope on the output pulse. To decrease the slope to the 1 % level without resorting to a 20 mF capacitor in the C1 location, the slope is corrected with a bouncer circuit. This is a resonant LC circuit which creates a single sine wave with a period of 7 ms. The bouncer is triggered slightly before the main pulse so that the linear, bipolar portion of the cycle is playing during the main pulse. The bouncer wave form cancels out the 20 % slope from C1, and reduces it to less than 1%.

The pulse rise time will be less than 50  $\mu$ s.

The power fluctuations seen by the mains are reduced to  $\pm 15$  % by the 3 Henry choke L1.

The modulator is described in more detail in a separate talk in this conference.

The overall modulator efficiency has been estimated to be 90 %.

The measured electronic efficiency of the Klystron is close to 45 %. Since we need at least 5 % power reserve for amplitude and phase regulation, we cannot operate the Klystron in saturation, and the effective Klystron efficiency reduces to 40 %.

The assumed power loss in the circulators is 4 %, and the Klystron focusing solenoid needs a continuous power of 3.8 kW. Hence, for a duty cycle of 2.07 % the wall-plug power to RF power efficiency for a 5 MW source is about 30 %.

It should be noted here that we are triggering developments for future Klystrons with the efficiency goal of 75%, ( see last section ), and it seems also possible to develop circulators with an insertion loss of .1 to .15 dB, i.e. about 3 % , so that ultimately an overall efficiency above 60 % should be reached.

The power loss in the second hand circulators, which we presently have, is 15 %.

### Interlocks

In the event of a Klystron gun spark, which is detected in three different ways for redundancy, we must keep the energy deposited in the spark below 20 Joules to avoid damage of the gun.

Our response to a spark will be to immediately open switch 1, and to allow the stored energy in the transformer leakage inductance to be dissipated in the 80  $\Omega$  resistor across the transformer primary. The 100  $\mu$ F capacitor limits the peak inverse voltage at the primary to 800 V when S 1 is opened.

Should S1 fail to open, an ignitron crowbar across C1 is fired and, in addition, a second independent switch installed in series with S1 is opened.

Important interlocks are control of cooling water flow and temperature, the focusing solenoid current, and a two level vacuum interlock which shuts down the high voltage once the upper level is reached, due to a spark, for example. High voltage stays OFF for at least a minute, in no case operation is restarted before the vacuum has fallen below the lower level.

Other interlock conditions result from sparks in the RF distribution system, wave guide pressurization (see below),reflected power, RF leaks, power couplers and from cryogenics.

### The RF Distribution System

There are four cryounits in the TTF and the RF distribution system is based on one Klystron for two cryounits. Each unit contains eight 9-cell cavities. The distance between adjacent cavities is  $3/2 \lambda$ . Therefore the phases are identical at each feed point. In principle, a tree-like RF distribution can be used, but a linear system branching off identical amounts of power from each cavity from a single line by means of directional couplers matches the linear tunnel geometry better and will be installed for the TTF. Such a system is already in use for the HERA superconducting RF system and all required components are readily available.

One might object that unlike the case of the tree-like system, where all paths have the same electrical length, thermal expansion could be a problem for the linear distribution system. Fortunately the effect is only .24 $^\circ$  of RF phase per centigrade and per kryomodule and is therefore uncritical.

The total power of 4.5 MW (including a safety margin of 30 % for eventual overcoupling or to compensate for tuning errors) is symmetrically divided by one magic tee and feeds the two cryomodules, see Fig. 7. Individual three stub wave guide tuners for impedance- and phase matching of each cavity are planned. They provide the possibility of  $\pm 30^\circ$

phase adjustment and to correct for VSWR up to 2.1:1.

Circulators are indispensable. They have to protect the Klystrons against reflected power and, in conjunction with load resistors and the power input coupler, they define the loaded cavity impedance as seen by the beam. The circulator will be located between the Klystron and the magic tee.

Since, due to cavity filling, there is almost total reflection of the RF power at the beginning of the pulse, the standing wave RF voltage which occurs in the circulator and in some parts of the wave guide system may double. In other words, with respect to sparking protection, the equivalent power to be considered is 4 times the real power entering into the circulator, i.e. almost 20 kW. Assuming a breakdown field of 30 kV/cm, the recommended power rating for WR 650 wave guide is 14.8 MW for straight wave guide under ideal conditions, which means dry and clean.

Of course, the wave guide lengths will be arranged so that the reflected powers from each kryomodule will add up constructively in the load associated with the magic tee rather than propagating to the circulator. This can work perfectly only if both power signals arrive with equal amplitude and proper phase at the magic tee. Clearly it is unrealistic to hope that this will always be the case.

Therefore we will fill the wave guide section between the Klystron and the magic tee with the protective gas SF<sub>6</sub> of normal pressure, which can increase the power handling capability by up to 8 times. The disadvantage of SF<sub>6</sub> is that, if sparking occurs, aggressive radicals are formed, and one may have to change the gas in order to avoid wave guide corrosion. Other gases would require an overpressure of several bars to get the same relative power capability as SF<sub>6</sub> at normal pressure.

We are confident that the long wave guide sections after the magic tee can be operated with normal air since here the equivalent power corresponding to the worst case standing wave voltage should stay below 8 MW.

In principle one can imagine to simplify this proposed RF distribution scheme and reduce cost by replacing the directional couplers (and their loads), which branch off the main wave guide identical amounts of power for each cavity, by doorknob or crossbar couplers, and make sure that the distance between all these couplers equals an integral multiple of  $\lambda/2$ . Then, electrically, all cavities are in parallel. However, a detailed study investigating the effects of reflected power and cross talk between cavities under all possible circumstances in this case needs yet to be performed.

### Phase and Amplitude Control

The beam energy resolution, which can finally be obtained in the linac depends, amongst other things, on the phase and amplitude stability of the accelerating RF. The latter is controlled by the circuits depicted schematically in Fig. 8. The limiting factors, which are reviewed in the following, were extensively discussed and derived during the last workshop on RF Superconductivity<sup>2</sup> held at DESY two years ago.

Possible sources of phase or amplitude errors are:

### Errors in Cavity Tuning

Each cavity has an individual tuner and it was estimated that the tuning angle could be adjusted to within  $10^\circ$ , giving  $\Delta E / E = 3 \cdot 10^{-2} / \sqrt{N_{\text{cav}}}$  for uncorrelated tuning errors.  $N_{\text{cav}}$  is the number of cavities.

The tuner input signals are derived from an individual cavity voltage pick up in each cavity and from a common forward power signal, which comes from the directional coupler between the Klystron and the circulator. Due to the finite directivity of the directional couplers it would be difficult or even impossible to get such a signal behind the circulator given the large amount of reflected power during cavity filling, and whenever one operates without beam. This is usually the case when initial tuner adjustments are made. The thermal effect on the wave guides can be minimized by adjusting the tuner offset only after thermal equilibrium has been reached.

### The Effect of Microphonics

Phase shifts due to microphonics are assumed to be smaller than  $\pm 1^\circ$  because of the stiffened cavities.

### Error in Phase of RF Drive

It is also assumed to be kept below  $\pm 1^\circ$  either by optical transmission or by a resonant drive line.

### Fluctuations of Generator Power and Phase

According to experience they can be kept below .2 % short term stability, leading to

$$\Delta E / E = 2 \cdot 10^{-3} / \sqrt{N_{\text{power sources}}}$$

Presently we plan to have a common feedback loop, which stabilizes the scalar voltage sum of all cavities fed by one Klystron. Assuming that all tuners work properly, one might consider the RF phase signal of one single cavity to be a sufficiently good representative of all the other cavities and use it as an input for the phase loop, which is closed around the Klystron. Tests involving the vector sum of all cavity signals are also foreseen. We believe that phase stability of  $\pm 1^\circ$  can be reached.

### Errors in Relative Phase between Beam and Cavity RF Voltage

The proper timing of the cavity RF voltage relative to the beam can be defined by first tuning the beam loaded cavity to maximum RF voltage. Subsequently the phase of the Klystron induced voltage is tuned until a minimum in total cavity voltage is achieved. Ideally, for this adjustment, the magnitudes of Klystron induced cavity voltage and beam induced one should be equal. Then, the total cavity voltage is zero at the correct phase which, therefore, can be detected with a precision of better than a degree. A slow phase loop (not shown in Fig. 8.) must stabilize the Klystron drive RF phase to the beam signal to a similar precision over longer periods of time. The input signals to this loop can be the RF voltage signal from one cavity and a filtered beam monitor signal. Assuming a maximum phase error of  $\pm 5$  degrees for an individual Klystron, the total energy spread is  $\Delta E / E = 7.6 \cdot 10^{-3} / \sqrt{N_{\text{power sources}}}$ .

### Errors in the Injection Phase

An error in injection time is more critical since its effect on the energy spread is not reduced by statistics. An error of  $\pm 1^\circ$  in injection phase ( corresponding to a time jitter of 2 ps ) gives already an energy deviation of .03 %.

It should be noted here that errors in the injection time on the microsecond scale will cause energy fluctuations too, even if the injection phase angle is correct. This is due to the exponential time dependence of cavity filling. Injection prior to the moment where the cavity voltage without beam has reached the nominal value will result in an RF voltage which is still rising during acceleration whereas too late injection will have the opposite effect. An error in timing  $\Delta T / T_{fill}$  of 1 % ( $\approx 5 \mu s$ ) yields a  $\Delta E / E = 1\%$ .

### Stability of Total Bunch Charge in a Batch of 800 Bunches

Here, an error of .1% results in  $\Delta E / E = .1\%$  for critical coupling. If, in practice, fluctuations of a few per cent of the total bunch charge occur, the resulting energy variations can, of course, be reduced by the amplitude feedbackloop. The price for this will be a loss of effective Klystron efficiency, which is proportional to the power reserve required for regulation.

Charge errors of individual bunches are much less critical (see below).

It was concluded that with the planned system a beam energy resolution of the order of 1% should be obtainable.

The hardware for phase and amplitude regulation has been built at FNAL. Installation at DESY together with the modulator is foreseen for December 1993.

### Beam Loading

In order to get a better feeling for the influence of errors in coupling ratio and fluctuations of individual or total bunch charge on the time dependent cavity voltage, beamloading calculations simulating these effects were performed.

In Fig.9 several cases are displayed. First we show the nominal case, where everything is matched. The rising cavity voltage is given by

$$U_{cav} = (( R/Q_0 ) * Q_L * P_G * 4 * \beta / ( 1 + \beta ))^{1/2} * (1 - \exp(- t / \tau )).$$

Here R,  $Q_0$  and  $Q_L$  are cavity shunt impedance, unloaded and loaded Q respectively. The Generator power is  $P_G$  and  $\beta$  is the coupling factor. The time constant  $\tau$  is given by

$$\tau = 2 * Q_L / \omega.$$

Once the cavity voltage has reached the nominal voltage of 25 MV in our case, the beam is injected and the voltage, which would rise up to 50 MV otherwise, stays constant as one can see in Fig. 9a.

The immediate voltage drop  $\Delta U$  of cavity voltage caused by the passage of a bunch of charge  $q$  is given by  $\Delta U = q / C$ , if the bunch arrives at the crest of the RF voltage. C is the capacity of the cavity. After the bunch passage, the cavity voltage rises again with the time constant  $\tau$ .

This microscopic behavior is shown in Fig 9 b.

The effect of random fluctuations of individual bunch charge of 30 % and 100 % is well below 1% as Figs. 9 c+d show. This is not unexpected since the energy stored in the cavity is about 400 times the nominal energy carried away by one bunch. In these calculations the finite group velocity of propagation of generator power in the multicell cavity has not been taken into account. Sekutowicz<sup>3</sup> has shown that the effect is small. Fig. 9 e shows that an error of 20 % in  $\beta$  causes a maximum deviation of 3 % from nominal voltage.

A 5 % change in total bunch charge or beam current changes the cavity voltage by 3 % during the duration of the pulse as is apparent from Fig. 9 f.

These results indicate that a power reserve of some 5 % may be sufficient to correct for the voltage deviations resulting from probably unavoidable errors in the coupling factor and from fluctuations of the beam current.

### Lorentz Force Detuning of the Cavities

Lorentz Force detuning of the stiffened cavity structures has been estimated<sup>4</sup> to be of the order of 400 Hz for the field gradient of 25 MV/m. Since the bandwidth of the loaded cavity is 465 Hz ( $QL = 2.8 \cdot 10^6$ ) a tuning error of 394 Hz corresponds to the detuning angle  $59^\circ$ . The voltage seen by the beam is then reduced by the intolerable factor  $\cos^2 59^\circ = .26$ .

Therefore, a fast tuning mechanism, which is effective on the millisecond time scale, where the detuning occurs, is needed.

The solution, which we propose and which has been realized at DESY, is indicated in Fig. 10. Phase detector 1 delivers a signal proportional to the detuning.

Subsequently it is converted into a frequency signal. Combining this signal with the one from the reference frequency source in the single sideband modulator yields a signal of frequency  $f_{ref} - f_{vco} = f_{cav}$ .

In this mode the detuning angle is always near zero because the cavity is driven at its proper resonance frequency, which depends on the square the RF fields.

Prior to injection of the beam, once the nominal RF voltage in cavity has been reached, one has to synchronize to the reference frequency signal.

If the cavity is mechanically tuned so that its resonance frequency at full RF gradient equals the reference frequency, this synchronization happens automatically since then, the output from the VCO is zero.

Measurements from A. Mosnier<sup>5</sup> have shown, however, that, due to mechanical properties of the cavity it's resonance frequency still changes after the nominal field has been reached. The resulting tuning errors can be minimized to about  $6^\circ$  (see Fig. 11) by introducing a frequency jump of the order of 200 Hz prior to injection of the beam as was shown by Henke and Littmann<sup>6</sup>. In practice, this means that the cavity is tuned so that its resonance frequency at the time when the full gradient is reached deviates by 200 Hz from the reference frequency. Forcing then the value of the VCO input signal to zero within some  $\mu s$  results in a frequency jump of the drive frequency. With this method one minimizes an a priori known tuning error by predetuning.

In an alternative concept, which is presently being built at Saclay, the cavity acts as a self excited oscillator during the filling time. Both methods will be tested soon at the MACSE accelerator in Saclay.

Since one Klystron drives 16 cavities, we must demonstrate that the resonance frequencies of individual cavities do not differ by more than 40 Hz to keep the tuning errors below  $10^\circ$ .



## Possible new RF sources for TESLA

With the present RF structure 1250 Klystrons would be needed for the TESLA 250 GeV + 250 GeV linac.

In order to reduce RF capital investment and running cost we have investigated the possibilities to halve the number of Klystrons by doubling the output power to 10 MW and to increase the electronic efficiency from the presently available 45 % into the 70 % region. The presently considered pulse length and repetition rate remain unchanged, i.e. 2 ms and 10 Hz.

Another goal is to increase the tube reliability so that a lifetime of the order of 70000 hrs is obtained.

We see the following possibilities to achieve this goal:

A means of increasing efficiency is the depressed collector. Here, the collector is divided into several parts, which are subjected to different potentials, such that the residual electron beam is decelerated and the extracted electrical energy can be reinjected into the cathode voltage power supply. A gain of 20 % in efficiency due to the depressed collector has been reported for TV Klystrons. There is, however, no convincing scheme of applying this principle to our case, where pulsed RF is needed.

Improvement of standard Klystrons by increasing the cathode voltage to values around or above 200 kV. In this case, with the microperveance of .75, an efficiency of 70 % might be expected.

The microperveance  $P$  is defined as  $P = (I / U^{3/2}) * 10^6$ , where  $I$  and  $U$  are the Klystron beam current and voltage. The relation between efficiency and microperveance is shown in Fig. 12.

The increase in efficiency for small  $P$  is due to the reduction of space charge, which tends to blow up the beam bunches in the Klystron.

The inconvenience of this method is the high cathode voltage, which the Klystron has to endure during the long pulses of 2 ms. For pulse lengths in the  $\mu$ s range, operation at much higher voltages is possible.

A very attractive low perveance tube is the Multibeam Klystron (MBK), where the total beam current is carried by several separated electron beams rather than by a single one. The perveance per beam is thus reduced correspondingly. Such a tube is schematically shown in Fig. 13. The main advantage of MBKs is the relatively low operating voltage, which simplifies HV power supplies and X-ray protection. Furthermore, the overall tube length may be reduced by up to 50 % and the power output is 1.8 W / gram Klystron weight as opposed to .6 W / per gram for a normal Klystron.

A prototype of a 64 kW 4 beam Klystron operating at 425 MHz has demonstrated<sup>7</sup> an efficiency of 44 %. The cathode voltage was only 18 kV.

A proof of existence and feasibility of 5 MW L-band MBKs operating at ms pulse lengths comes from the Moscow Meson Factory, where 33 MBKs are running. These tubes have 6 beams and the operating voltage is only 75 kV. The microperveance of 1.4 per beam should allow for a higher efficiency than the 40 % of the actual tubes.

More recent designs of MBKs promise efficiencies between 60 and 70 %.

Last, but not least, we would like to mention a new RF source, the magnicon, which was invented by Oleg Nezhevenko from Budker Institute in Novosibirsk<sup>8</sup>.

The principle of operation can be understood from Fig. 14. A continuous electron beam from the electron source 1 reaches the circular deflection cavity 2 to be deflected there at an angle  $\alpha_0$  by an RF magnetic field rotating with deflection frequency  $\omega$ . The field distribution in the cavity is shown in Fig. 15. It is generated by the excitation of two degenerate  $TM_{110}$  modes. The maximum magnetic field from one mode coincides with the maximum electric field from the second one. In the drift space electrons deviate from the device axis and get into a stationary magnetic field  $B_z$  of the solenoid 3. While entering the magnetic field the longitudinal velocity of the electrons is transformed into a rotational transverse one, and the degree of transformation is characterized by the pitch angle  $\alpha$ . Further on, traveling along a helical trajectory and steadily changing their entering point in the output cavity 4, the electrons excite a wave in the cavity traveling along the azimuth ( $TM_{110}$ ) oscillation mode and transfer their energy to this wave. If the cyclotron frequency  $\Omega$  is equal to the operation one ( $\omega$ ), then the interaction can remain effective during many periods of RF oscillation. The particle energy is transferred to the electromagnetic field in the magnicon output cavity due to the decrease in the transverse component in its velocity at a practically constant longitudinal one.

Feasibility of the magnicon has been demonstrated by two prototypes. One has delivered 2.6 MW RF pulses of 30  $\mu$ s length at 915 MHz, the other has demonstrated 25 MW output power at 7 GHz for 2  $\mu$ s pulses. The reported efficiencies of these two magnicons are 73 % and 60 %. It is claimed that a 10 MW magnicon for TESLA could be built with an efficiency in excess of 78 %<sup>9</sup>. The disadvantage of the magnicon is its high operating voltage. For the TESLA magnicon it would be 250 kV.

Summarizing we can state that there are several promising alternatives for the development of high efficiency and high power L-band RF sources for TESLA. The decision which way(s) to go will be made within the next few months.

## References

- Ref.1: The TESLA Modulator, H. Pfeffer, C. Jensen, S. Hays, L. Bartelson, TESLA Report 93-30
- Ref. 2: Summary of RF working group, compiled by S. Noguchi and G. Geschonke, Proceedings of the 5th workshop on RF superconductivity held at DESY, Vol. 2, pp 1031-1043 , August 19- 23. 1991
- Ref. 3 : J. Sekutowicz, private communication
- Ref. 4: H. Kaiser, this conference
- Ref. 5: Dynamic Measurements of the Lorentz Forces on a MACSE Cavity, A. Mosnier, TESLA Report 93-09
- Ref. 6 : Mechanical Parameter Influence on the TESLA Cavity Tune under Lorentz Forces, H. Henke, B. Littmann, TESLA Report 93-12
- Ref.7 : Very long pulse high power Klystrons for FEL and their generating conditions, G. Faillon and C. Bearzatto, Int. J. Electronics, 1988, Vol. 65, No.3 , 579-588;  
Advantages of Multiple beam Klystrons, C. Bearzatto - M. Bres - G. Faillon, ITG 92 - Garmisch Partenkirchen 4-5 May 1992.
- Ref.8 : The Magnicon: A New RF Power Source for Accelerators, Oleg A. Nezhevenko, IEEE Particle Accelerator Conference Vol. 5, May 6-9, 1991, San Francisco, CA, USA

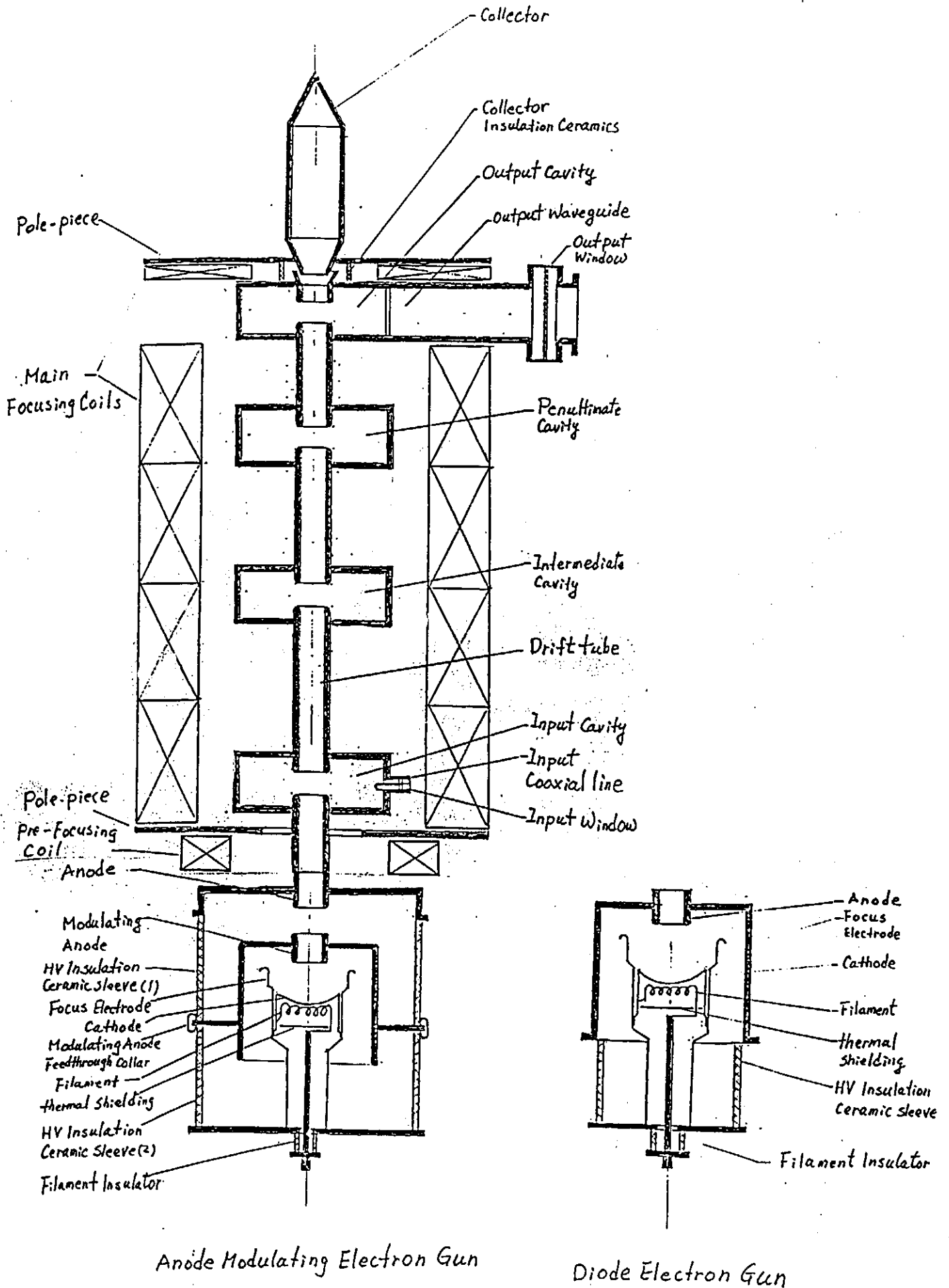

Fig. 1: Klystron with and without modulating anode.

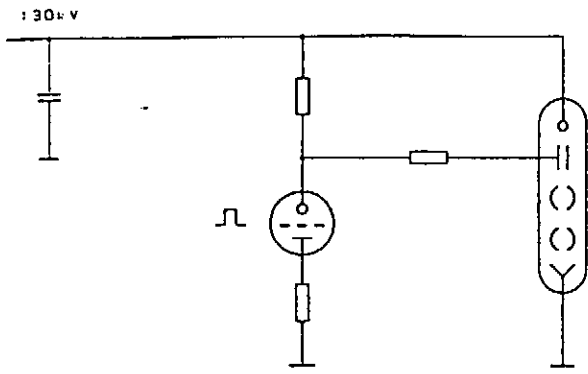

Fig. 2: Hard tube modulator for a Klystron with modulating anode. The beam current in the Klystron is controlled by the potential of the modulating anode.

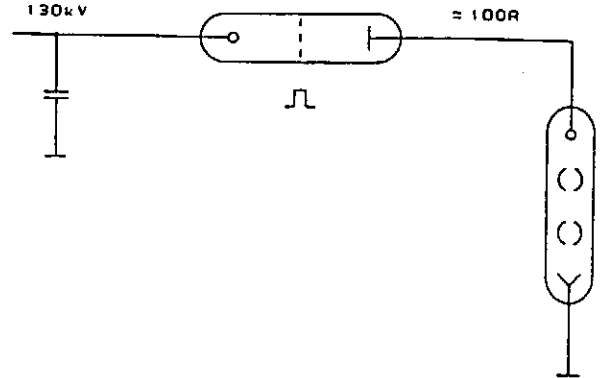

Fig. 3: Klystron modulator with a series switch tube.

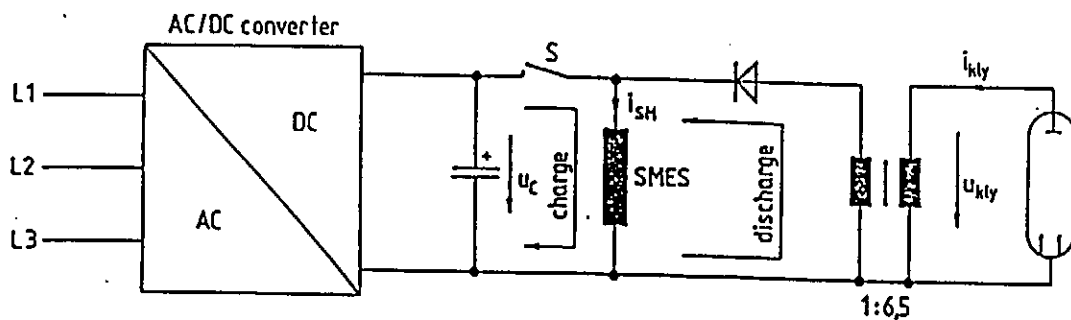

Fig. 4: Schematic electrical circuit of the Superconducting Magnetic Energy Storage (SMES) coil circuit coupled to a Klystron through a pulse transformer. Transfer of a part of the electrical energy stored in the superconducting coil requires switching of the high current in the coil at a 10 Hz rate. An appropriate switch and superconducting cable suitable for a dB/dt of 20 T/s corresponding to a pulse current droop of 2 % within 2 ms need to be developed.

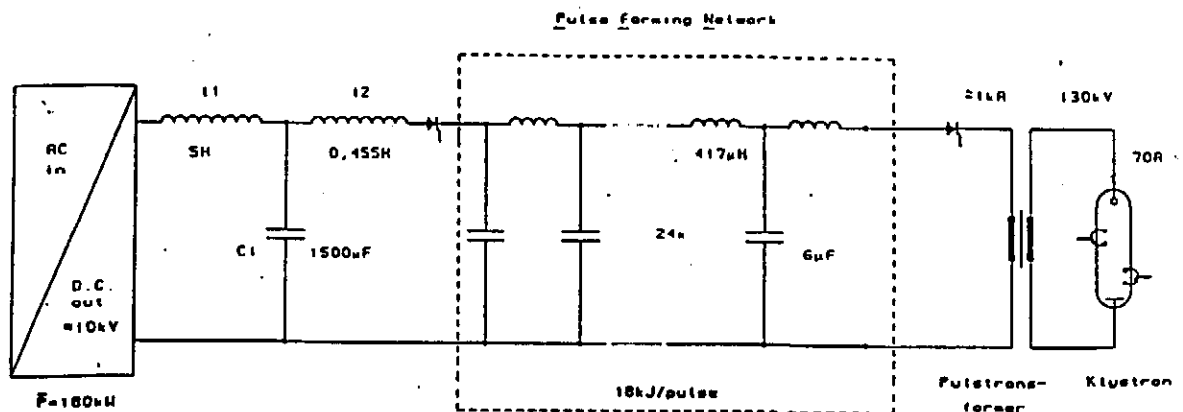

Fig. 5: Principle of a Pulse Forming Network (PFN) or Line Type Modulator. At the voltage level of 10 kV the network L1, C1 reduces fluctuations of the charging current of the subsequent PFN below the 5 % level. By discharging the PFN into the pulse transformer, a 2 ms 130 kV pulse is generated every 98 ms. The energy stored in the PFN is comparable to the total amount of energy needed per pulse, i.e. about 18 kJ.

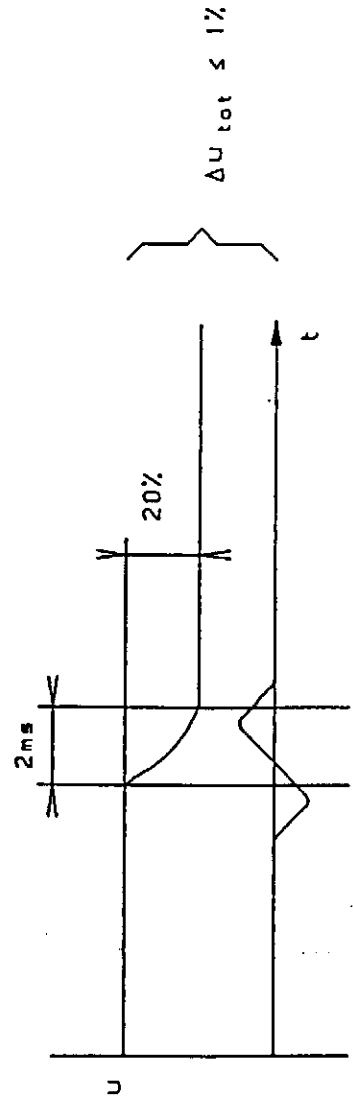
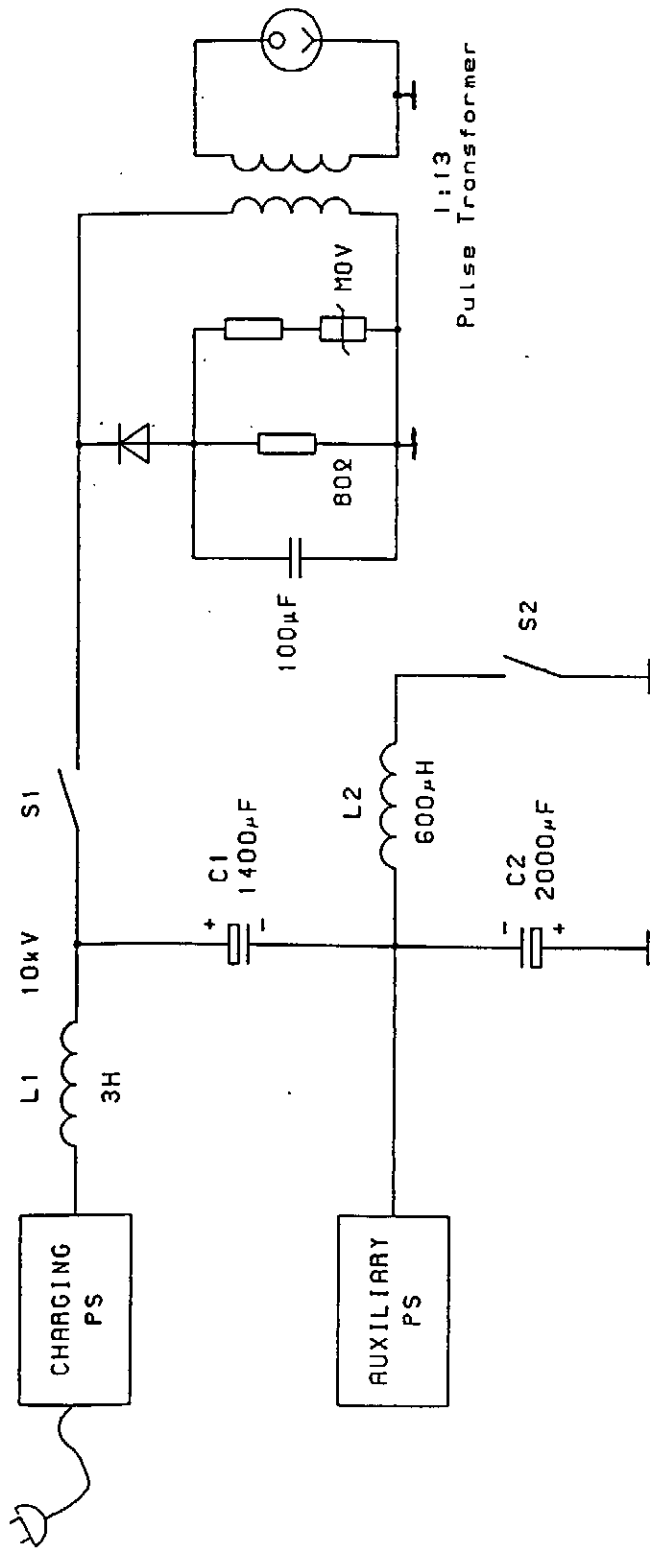

Fig. 6: Diagram of the TTF modulator with bouncer circuit designed and built by Fermilab. See text for further explanations.

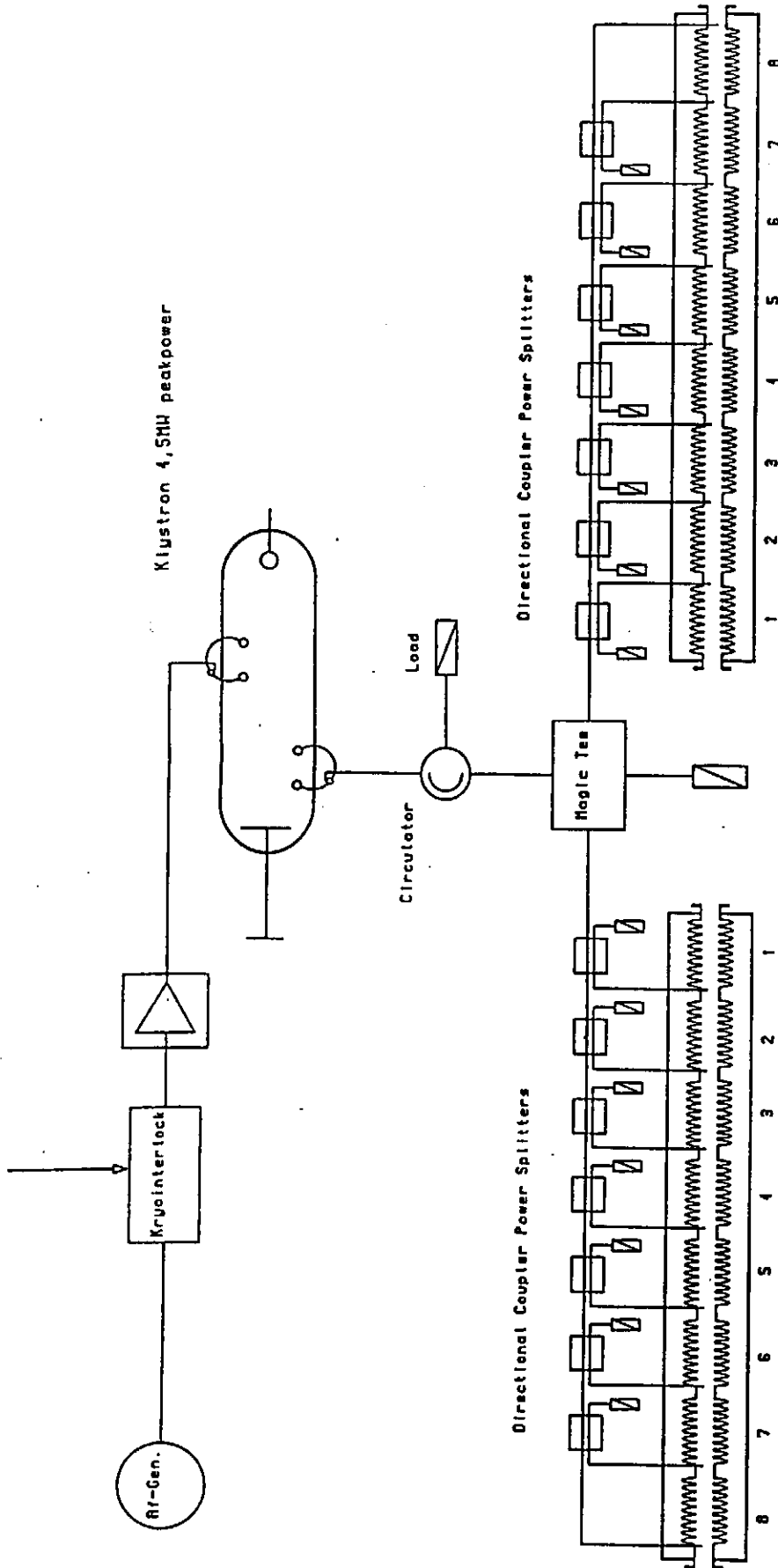

Fig. 7: Layout of the RF distribution scheme. One 5 MW Klystron feeds two cryounits. There are eight 9-cell hybrids in each unit. The coupler hybrids branch off equal amounts of power into the individual cavities. An interlock circuit switches off the RF drive in case of a quench or for other reasons like phase or amplitude errors.

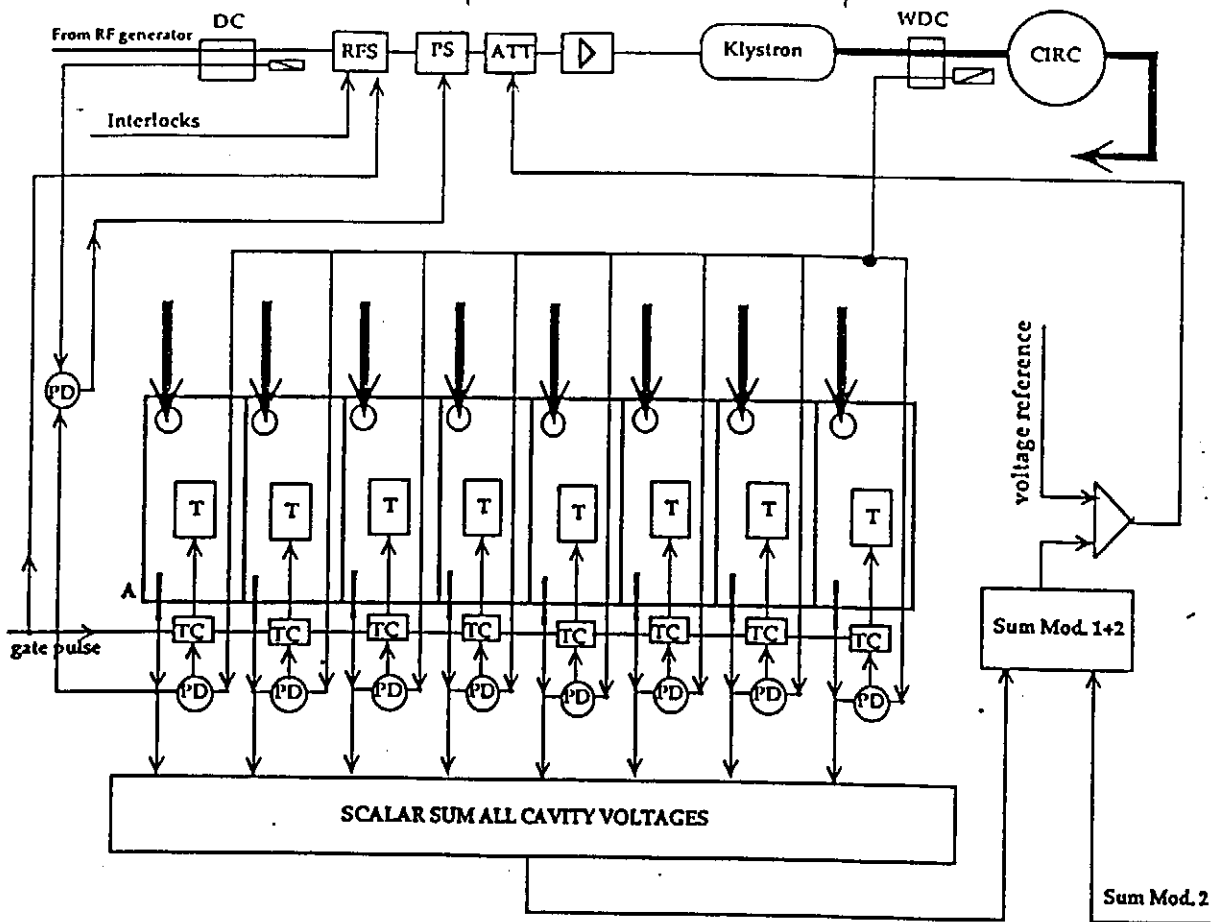

Fig. 8: Schematic of the phase, amplitude and tuner control circuits.  
 DC - coax directional coupler, WDC - wave guide directional coupler, T - cavity tuner,  
 TC - gated tuner control, PD - phase discriminator, RFS - RF switch, PS - variable phase  
 shifter, ATT - variable attenuator, CIRC - circulator.



Fig. 9 a - c: Calculation of beamloading under various circumstances.

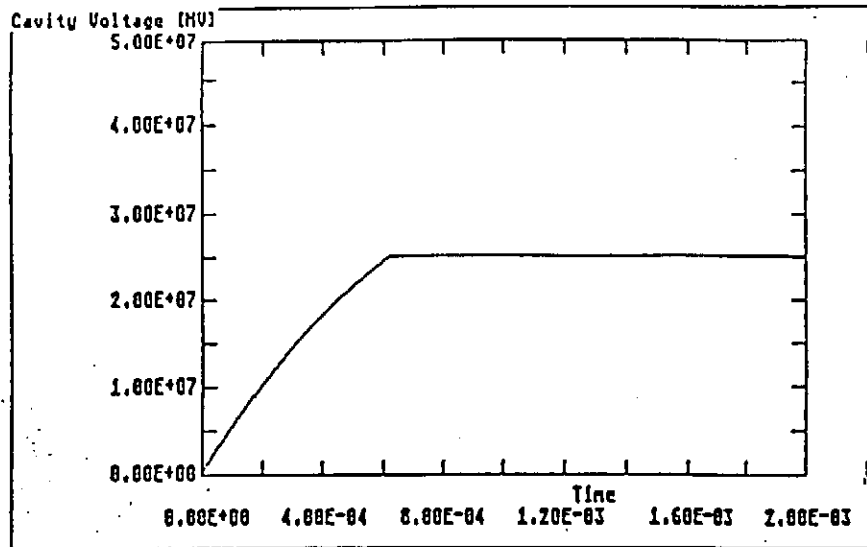

Fig. 9 a: Matched case. Once the cavity voltage has reached the nominal voltage of 25 MV in our case, the beam is injected and the voltage, which would rise up to 50 MV otherwise, stays constant.

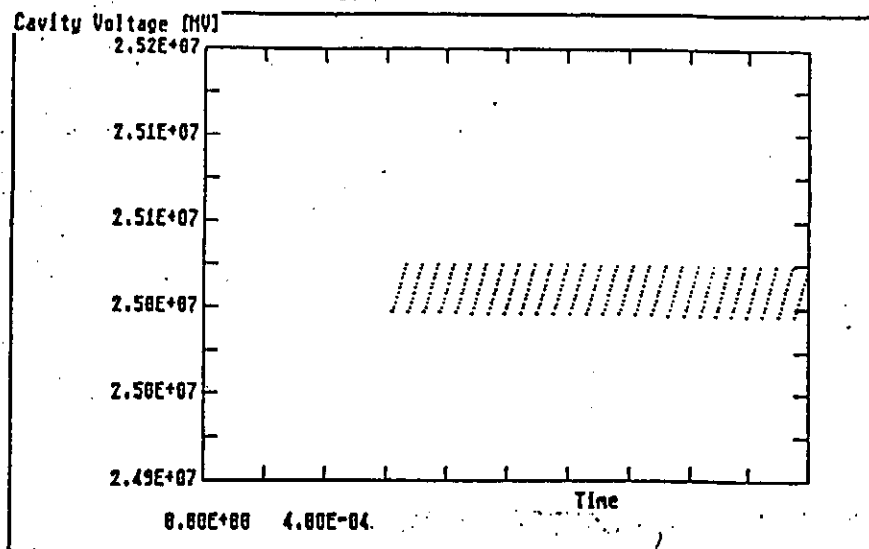
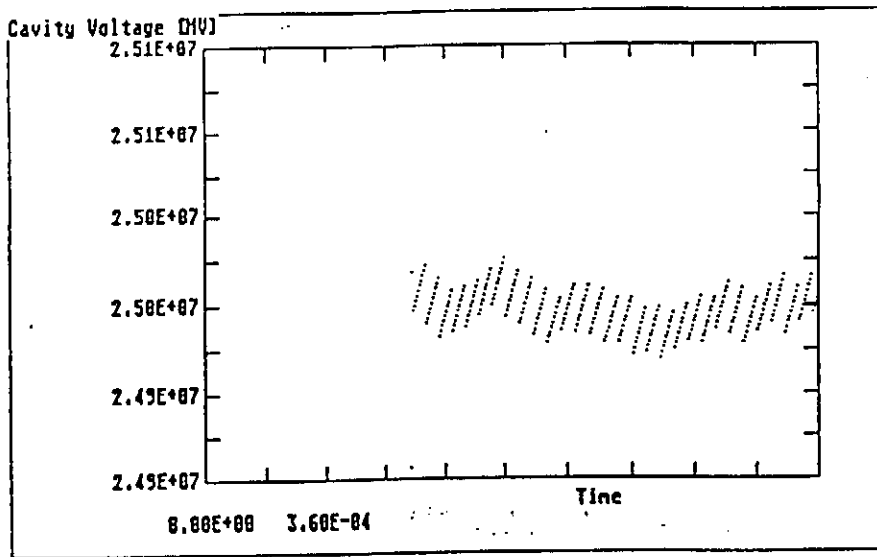
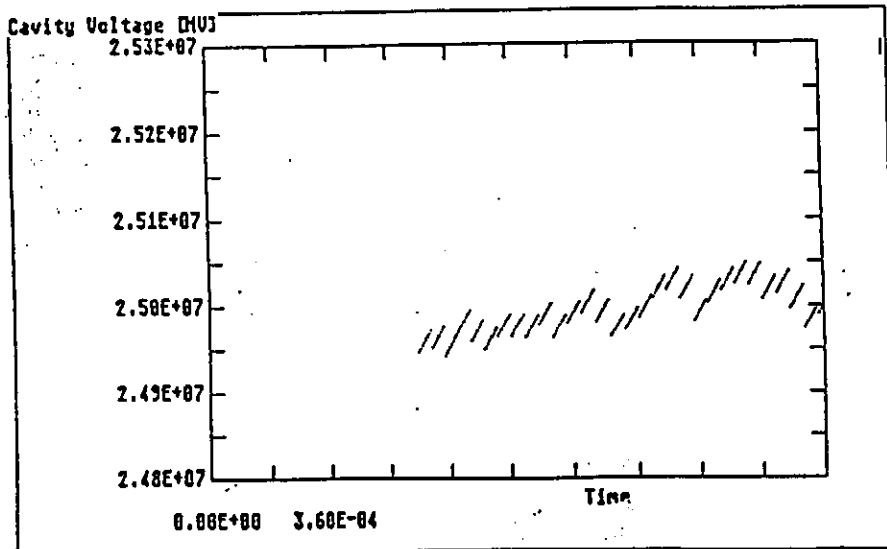

Fig. 9b: Microscopic behaviour. The immediate voltage drop  $\Delta U$  of cavity voltage caused by the passage of a bunch of charge  $q$  is given by  $\Delta U = q / C$  if the bunch arrives at the crest of the RF voltage.  $C$  is the capacity of the cavity. After the bunch passage, the cavity voltage rises again with the time constant  $\tau$ . The time spacing between individual bunches is  $1\mu\text{s}$ . Note the zoomed vertical scale.



9c

Fig. 9 c + d: The effect of random fluctuations of individual bunch charge of 30 % (9 c) and 100 % (9d) is well below 1%. This is not unexpected since the energy stored in the cavity is about 400 times the nominal energy carried away by one bunch. Note the zoomed vertical scale.



9d

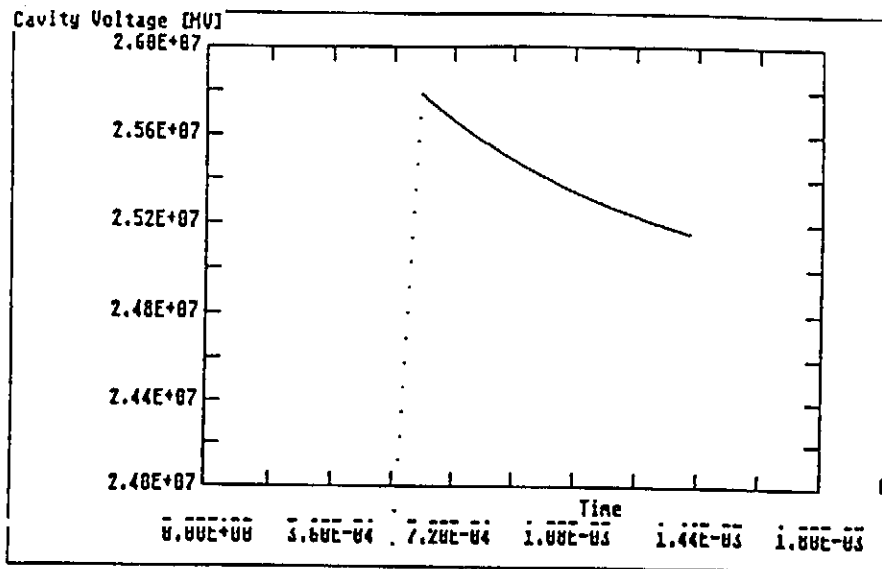

Fig. 9 e: An error of 20 % in  $\beta$  causes a maximum deviation of 3 % from nominal voltage.

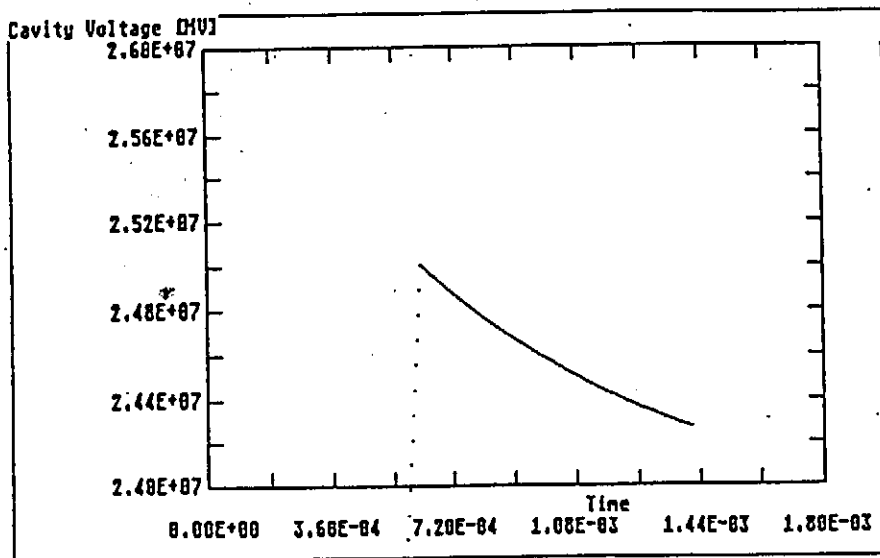

Fig. 9 f: A change of 5 % in total bunch charge or beam current changes the cavity voltage by 3 % during the duration of the pulse.

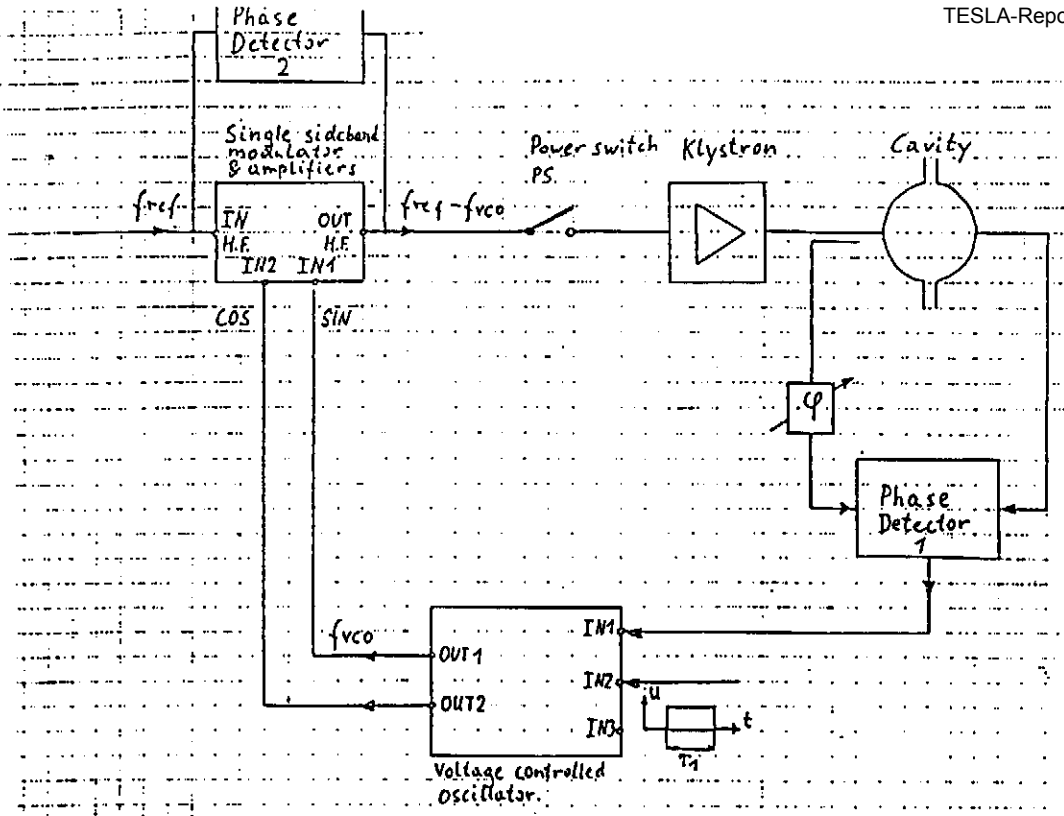

Fig. 10: Block diagram of circuit to cope with Lorentz force detuning of the cavities. See text for further explanations.

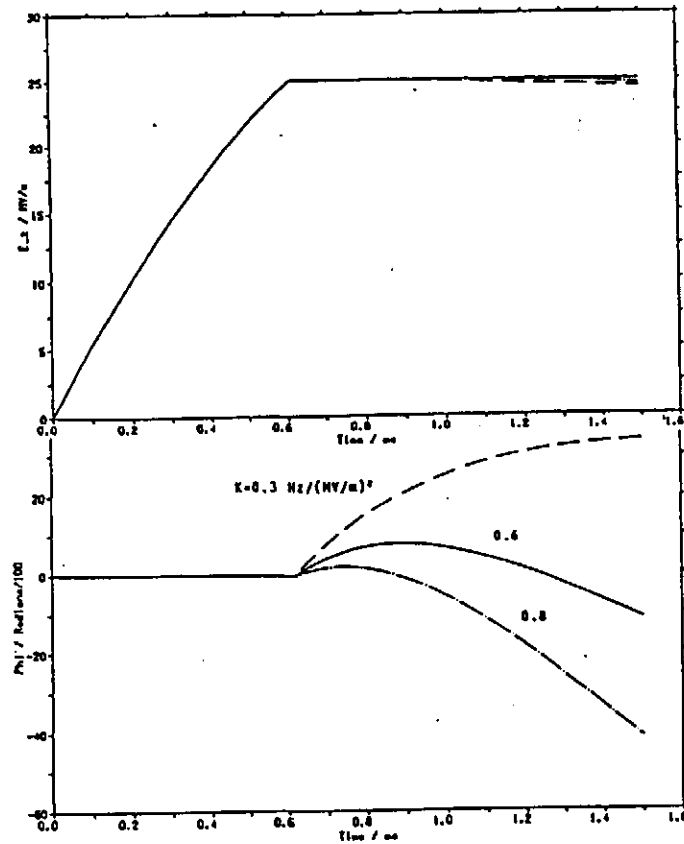

Fig. 11: (Taken from ref. 6). Due to mechanical properties of the cavity its resonance frequency still changes after the nominal field has been reached. The resulting tuning errors can be minimized to about  $6^0$  by introducing a frequency jump of the order of 200 Hz prior to injection of the beam as was shown by Henke<sup>6</sup>. During filling of the cavity the generator frequency is locked to the cavity resonance frequency and there is no phase error.

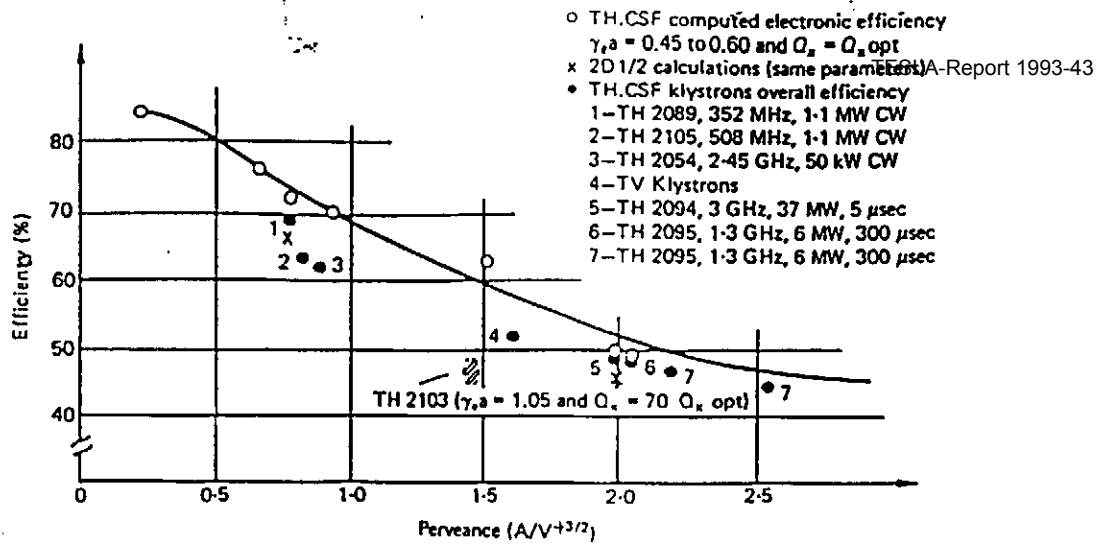

Fig. 12: ( Taken from ref. 7) Influence of Perveance on Klystron efficiency.

### THOMSON TUBES ELECTRONIQUES

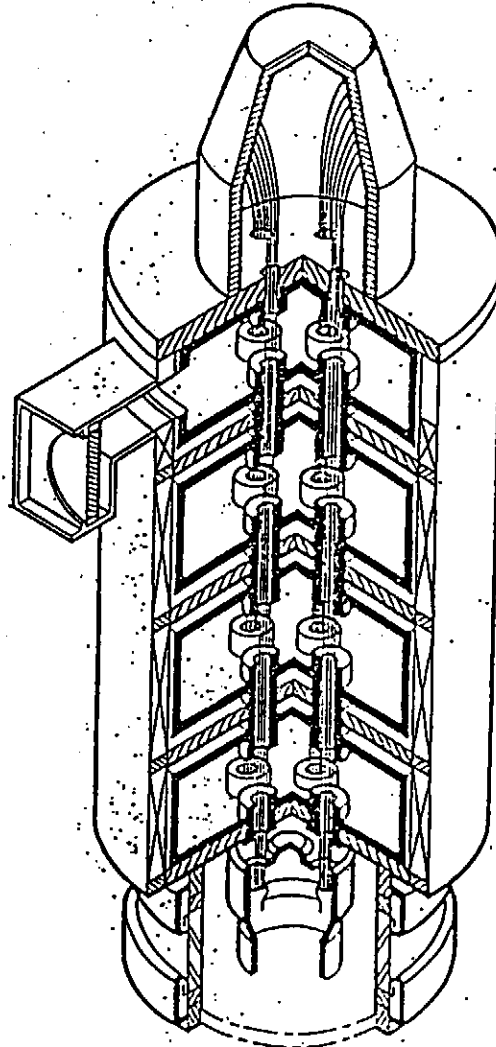

Fig. 13: ( Taken from ref. 7) Structure of Multibeam Klystron

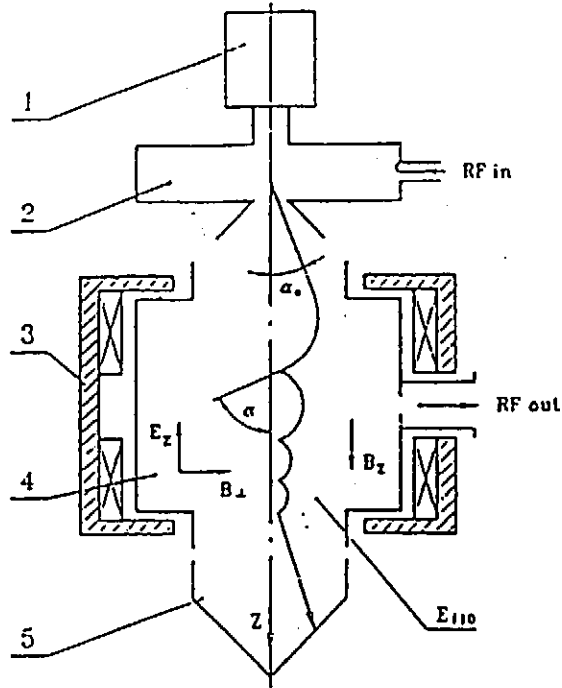

Fig. 14: ( Taken from ref. 8) Schematic of the magnicon:  
 1—source of electrons; 2—circular deflection cavity; 3—solenoid;  
 4—output cavity; 5—collector.

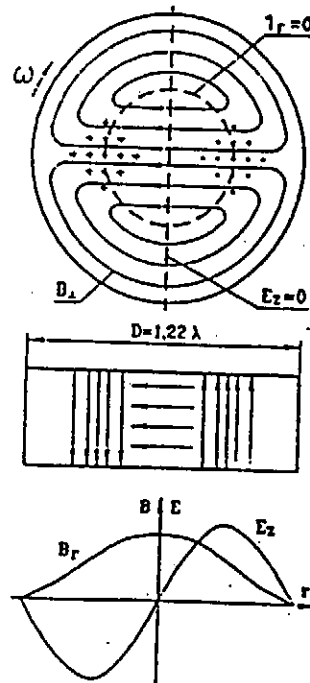

Fig. 15: ( Taken from ref. 8) Distribution of electromagnetic fields in magnicon cavities.

# Status and Parameters of the TH 2104 C Klystrons

## for TTF

Commissioning at Thomson took place in July.

Both tubes fulfill specification, one has been sent to  
FNAL.

### Measured Parameters:

Frequency:	1300 MHz	
Pulse length:	547 $\mu$ s	
Repetition rate:	40 Hz	
Beam Voltage:	130 kV	
Beam Current:	89 A	
Perveance:	$1.94 \cdot 10^{-6}$	
Drive Power:	45 W peak	
Output Power:	5.1 MW peak	102 kW average
Body Dissipation :	3.2 kW max.	
Efficiency:	44.7%	
Gain:	50.5 dB	
Bandwidth:	7 MHz	

Table 1